

UCW SERIES FRONT COUNTERS

UNDER COUNTER WINDOW COOLER DISPLAY





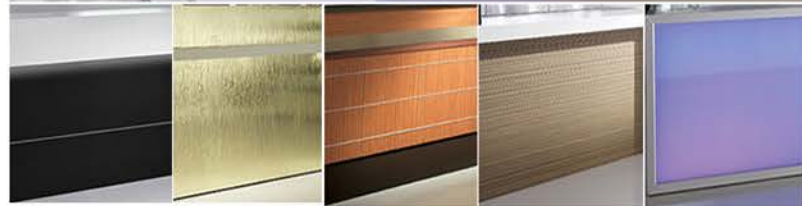

ALL METAL CONSTRUCTION

STANDARD FEATURES

- ETL approval for UL safety and NSF sanitation
- Patented access system for electrical plumbing and refrigeration
- Stainless steel adjustable feet
- AISI 304 stainless steel module with BA external finish and 2B internal stainless steel
- Round corners inside the model
- Ecological CFC free polyurethane foam
- Stainless steel intermediate and adjustable shelf
- High capacity evaporator with fan system
- Digital Dixell control with safe housing
- Stainless steel counter bar
- Glass doors
- Ventilated refrigerated
- Self contained
- Steel frame



OPTIONS

- Humidity control for praline (208-220V)
- Stainless steel doors
- Stone top
- Casters
- Work top options:
 -  Flat
 -  Back splash 8"H
 -  Pre-arrangement for service top
 -  Round per "Compact Round"

UNDER COUNTER WINDOW DISPLAY SPECIFICATIONS

MODELS	LENGTHS	DEPTHS	HEIGHT	WEIGHTS (LBS)	VOLTAGES	AMPS
UCW1300	50 3/4" (1286mm)	28 1/4"D (720mm)	36 1/4" (920mm)	345LBS	120V	6A
UCW1800	70 3/4" (1800mm)	28 1/4"D (720mm)	36 1/4" (920mm)	440LBS	120V	8A
UCW2300	90 1/2" (2300mm)	28 1/4"D (720mm)	36 1/4" (920mm)	490LBS	120V	10A

* Manufacturer reserves the right to change specifications without notice. Not responsible for error and omissions.



361-367 Beach Road, Burlingame, CA 94010
 Tel: 855.885.2400 | 650.342.2400 | Fax: 650.342.7400
 sales@oscartek.com | www.oscartek.com



OPTIONAL: BACK SPLASH 8" H SHOWN

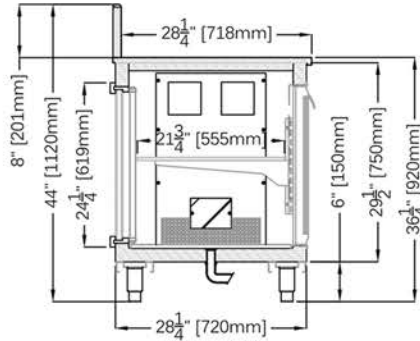
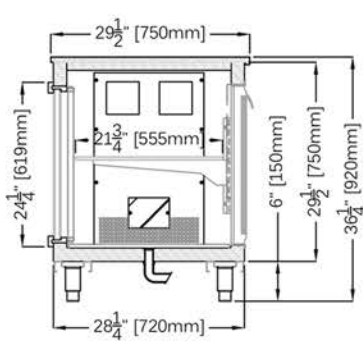

1300



1800

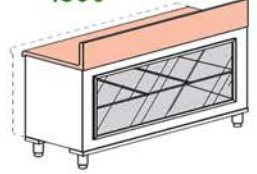

PLAN VIEWS

UCW1300

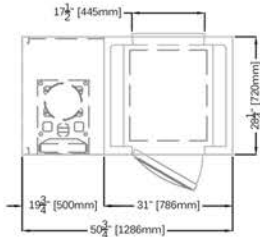

UCW1800

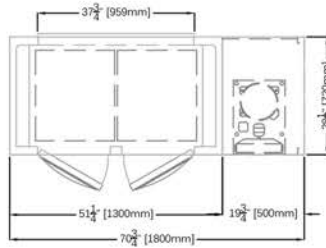

UCW2300

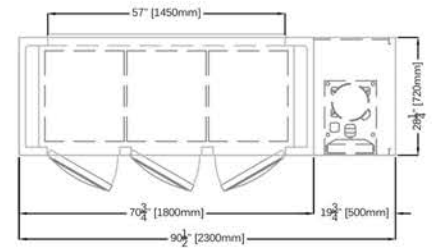

REAR ELEVATIONS (OPERATOR SIDE)

UCW1300

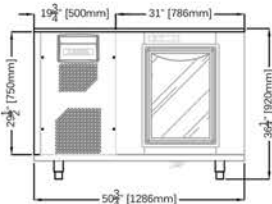

UCW1800

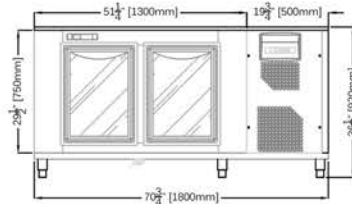

UCW2300

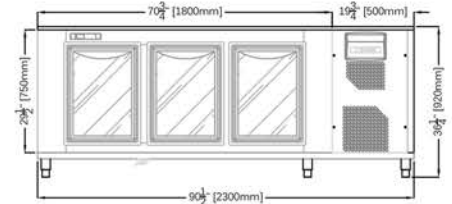

FRONT ELEVATIONS (CUSTOMER SIDE)

UCW1300

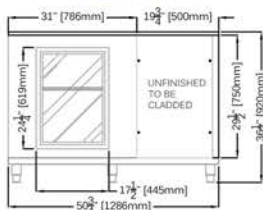

UCW1800

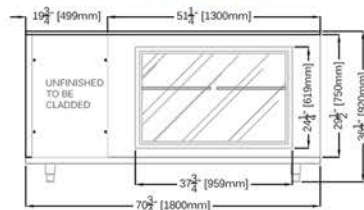

UCW2300

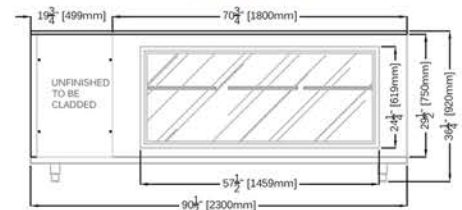

* Manufacturer reserves the right to change specifications without notice. Not responsible for error and omissions.



361-367 Beach Road, Burlingame, CA 94010
Tel: 855.885.2400 | 650.342.2400 | Fax: 650.342.7400
sales@oscartek.com | www.oscartek.com

